

1
関連資料類

版数

年月日

2
訂正内容

3
担当

確認

承認

A

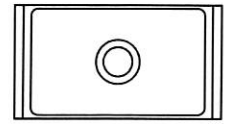
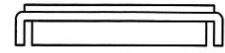
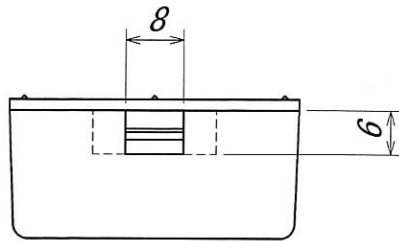

マグネット収納ポケット

B

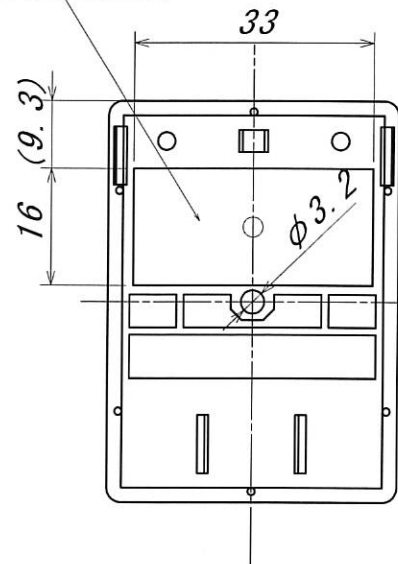
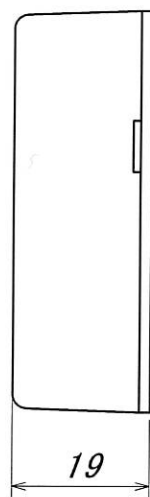
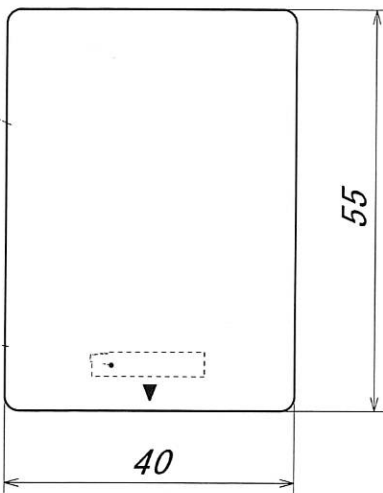

A

C

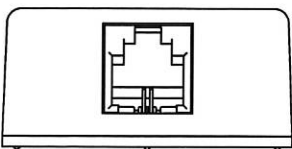

D